

LCD Panel PC

RS-5622N All-In-One 22" LCD Panel PC User's Guide

Version: A1.0



Users guide-Ver. A1.0
Mar, 2009

Notice

Copyright

The copyright of this user's guide belongs to any authorized company and is protected by copyright law. This means partial or full duplication of this document (electronically, mechanically or otherwise) is prohibited without the permission of the authorized company.

The contents may be modified without notice for the improvement of design, function, and reliability.

We do not guarantee the prevention of data loss. Please be cautious not to lose important data and keep back-ups at all times.

Even though we did our best in drawing up this user's guide, there may be omissions and errors we failed to notice. Manufacturers and suppliers cannot be held liable for problems stemming from those errors and omissions.

Registered Trademark

Microsoft Windows Vista is a registered trademark of Microsoft.

Intel Core 2 Quad, Core 2 Duo, Dual Core are registered trademarks of Intel.

Company names and product names mentioned in this document are used to help your understanding and are registered trademarks.

The permissible level (Class B) of electromagnetic waves

The product was tested for electromagnetic waves and was rated as class B, certified for sale and use worldwide.

Caution

For safe and proper installation and use of this product, please read this guide carefully.

Even though this product is equipped with a safety device to prevent users from getting injured, please follow the instructions carefully.

Caution during installation

- Install on an even and stable place to prevent product damage and injury.
- Install in a place with good ventilation to reduce humidity and to prevent overheating.
- Keep objects with magnetic properties away from this product.
- Check the operational voltage before plugging the power cord into the outlet.
- Use the power cord that is included with the product and do not place heavy things on it.
- To prevent electric shock and fire, do not use an outlet that is damaged or that is not standard.
- If you plug the power cord into an extension cord, be sure that the total voltage of all the devices connected to the cord does not exceed the number specified on it.

Caution during use

- If peripheral equipment is connected to this product, turn on the power source of the peripheral equipment first when you starting up. On the contrary, when shutting down, turn off the power source of this product first to prevent damage to the product.
- Please make sure that no liquid enters into the product. This can cause damage to the product, fire, or electric shock.
- Unplug the power cord before cleaning this product. Please

wipe with tissues or fabrics that are sprayed with a PC cleaner and do not directly spray the product.

- When this product will be idle for an extended period of time, unplug the power cord to prevent damage stemming from power surges.
- When unplugging the power cord, pull by the plug, not the wire.
- Do not place this product in a place where the temperature is over 60°C (140 °F) and ventilation is poor. This may damage the product.
- The optimum temperature for the operation of this product is 40°C, so keep electric heaters away from this product.
- Take precautions to avoid losing data stored on the hard disc of this PC and back-up important data at all times in case of an unforeseen accident.
- Do not attempt to disassemble this product. When this PC needs repairs or updates, request warranty service and have a service person do the work.
- Should the following situations occur, contact one of our quality assurance divisions.
 - ✓ When liquid gets into the product or when it is exposed to humidity for an extended time
 - ✓ When this PC does not operate well even though you are following the instructions
 - ✓ When this product has fallen and broken or become cracked during delivery.

Table of Contents

Notice	2
Copyright.....	2
Registered Trademark	2
The permissible level (Class B) of electromagnetic waves	2
Caution.....	3
Caution during installation	3
Caution during use.....	3
Table of Contents	5
Chapter 1. Introducing the LCD PC.....	7
Product features.....	7
Unpacking	8
Optional devices	8
Other peripherals	9
Preparing you LCD PC	10
Connect the AC Power Adapter.....	10
Turn ON the LCD PC.....	11
Chapter 2. Knowing the Parts	12
Front sides :	12
Right Sides :	14
Left Sides :	15
Rear Sides :	16
Install TV cable step :	17
Chapter 3. Starting the computer for the first time.....	18
For Windows Vista Home Edition	18
Step 0: Windows Vista and basic driver pre-setup	18
Step 1: To set up the computer.....	19
Step 2: The installation of drivers for other peripherals	21
Step 3: The installation of software for other peripherals.....	21
Step 4: Completion of setup.....	21
Chapter 4. Using the computer	22
To Use Windows Vista Home Edition	22
Using other applications.....	23
Partitioning the hard disk	23
Chapter 5. System Upgrades	24
System upgrades	24
Hardware upgrades	24
Software upgrades.....	24
Chapter 6. Reinstalling the OS	25
How to reinstalling Windows Vista.....	25
Appendix 1. Troubleshooting	27
Appendix 2. Product specifications and system diagram	30

Appendix 3. Product warranty 34

Chapter 1. Introducing the LCD Panel PC

Product features

LCD Panel PC is the all-in-one PC that combines a 22" TFT-LCD monitor and a desktop computer, offering an ultra light weight of 10.5 Kg and a modern design that suits any working conditions.

LCD Panel PC is so user-friendly that anyone can use it without difficulty because it has all major components in its all-in-one main body.

Even though the LCD Panel PC is very compact, its functionality is limitless. It supports out-dated and conventional peripheral devices, adapting to users' working environments. It also supports the latest peripheral devices with its four built-in USB ports (compatible with USB v2.0).

The PC enables wireless networking without additional equipment using its built-in network adaptor.

The PC's 22" TFT-LCD display, directly driven by digital signals, offers a clearer image than that of separate TFT-LCD monitor of the same class, which is driven by analog signals. Furthermore, it allows for the use of extended screens and has multi monitor functionality because it is equipped with an extension port for connecting to TVs or other external monitors.

This PC is designed to run best using Windows Vista, Microsoft's latest operating system. When used with the Windows Vista operating system, you can get a more stable and diverse computing environment.

The adoption of a 22" TFT-LCD monitor minimizes harmful electromagnetic waves and power consumption. Its design is engineered for the human body to minimize eyestrain.

Unpacking

This product is packaged with cardboard paper for safe delivery. If there is a defect or missing part, contact the agency where you purchased the product.

The box should contain the following items.

- ✓ 22" LCD Panel PC main body
- ✓ 180W AC/DC power adapter
- ✓ AC power cord
- ✓ Users Guide (This document)
- ✓ Master CD (with the driver file for backup)

Optional devices

- ✓ PS-2 wheel mouse
- ✓ PS-2 keyboard
- ✓ Wireless LAN mini-pci card & Antenna (built in the main body)
- ✓ Bluetooth module (built in the main body)
- ✓ TV Tuner mini-pci card (built in the main body)
- ✓ TV cable connector and remote control (for TV Tuner)
- ✓ Microsoft Windows Vista Home Edition installation CD
/ Driver Recovery CD

A touch screen is optional and you can order it before the product is shipped. To enable touch screen, you need to have the following device; Please carefully the touch screen if you assembly system by yourself.

- ✓ 22" Touch Screen
 - Manufacturer: 3GI International Ltd.
 - Model name: 3G220-493320-W5-3H

[For reference]

This PC has a mini-PCI slot in its main body allowing for expandability with peripheral devices that have a mini-PCI card. Our company will launch new models can support wireless LAN or TV-tuner.

Other peripherals

This PC supports the following peripheral devices

- ✓ PS/2 Keyboard and Mouse
- ✓ Printer (USB)
- ✓ One serial communication port (COM1)
- ✓ Six USB devices (compatible with USB 2.0)
- ✓ External speakers/headphones
- ✓ External microphones
- ✓ External audio devices
- ✓ External monitors

Optional :

- ✓ External TV cable input

[For reference]

- **What is USB?**

USB is a high-speed serial bus standard for the connection of peripheral devices that reduces the use of valuable system resources. Devices that support USB are USB mice, USB keyboards, USB PC cameras, USB HDD, and USB memory sticks.

Preparing you LCD Panel PC

These are only quick instructions for using you LCD PC.
Read the later pages for detailed information on using your LCD PC

Connect the AC Power Adapter



1. Insert power cord into power adapter



2. Insert power adapter cable into "Power Adapter Input" of rear I/O panel



3. Insert power cord into AC power Socket

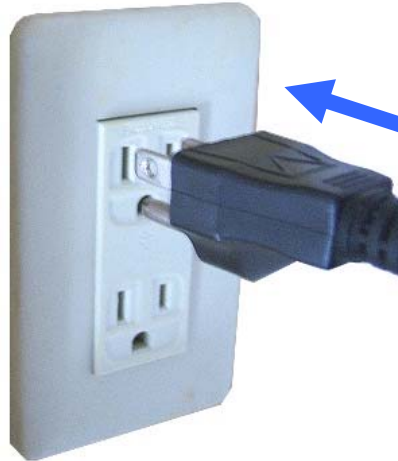

Turn ON the LCD Panel PC



LED

Power Button

1. Before turn on the LED is Red color.
2. Press the power button and release.

(In Windows Vista, this button can also be used to safely turn OFF the LCD PC.)

3. LED become Green color.

Chapter 2. Knowing the Parts

Front sides :

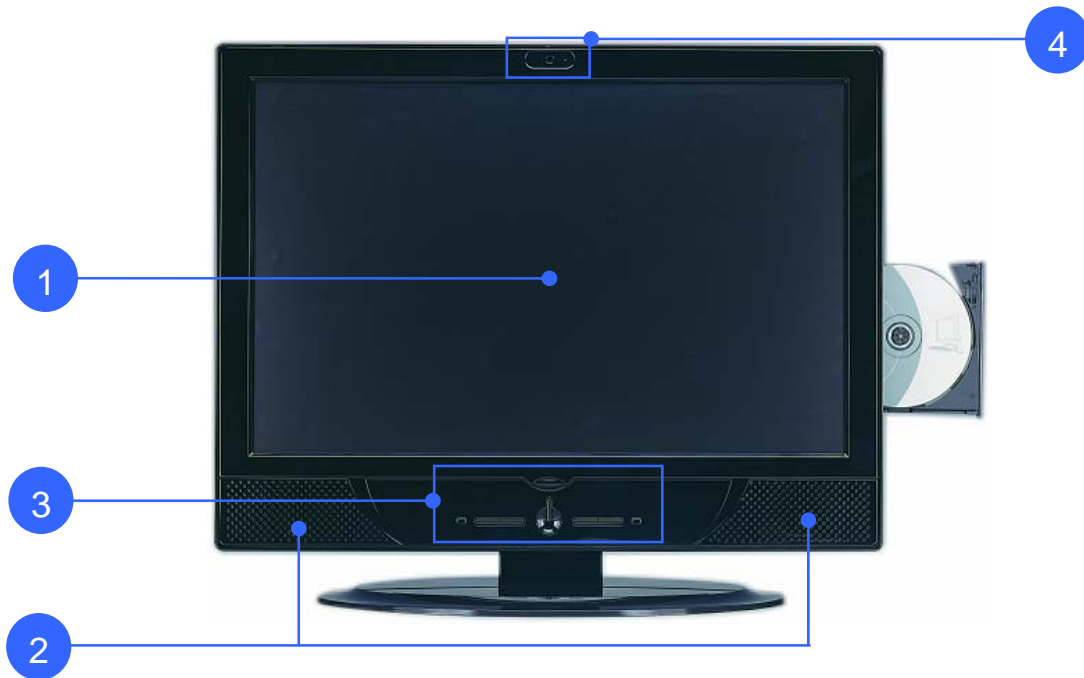

1

Display Panel

The display panel functions the same as a desktop monitor.

The LCD PC uses an active matrix TFT LCD, which provides excellent viewing like that of desktop monitors. Unlike desktop monitors, the LCD panel does not produce any radiation or flickering, so it is easier on the eyes. Use a soft cloth without chemical liquids (use plain water if necessary) to clean the display panel.

Pixels H x V : 1680 x 1050.

2

Audio Speaker System

The built-in stereo speaker system allows you to hear audio without additional attachments. The multimedia sound system features an integrated digital audio controller that produces rich, vibrant sound (results improved with external stereo headphones or speakers). Audio features are software controlled.

3

Instant Keys and Status Indicators



- **Power button**

 : Turns the computer on and off.

- **Buttons for adjusting the speaker volume**

 : Up() / Down() :
Adjusts the sound volume of the internal speaker.

- **Buttons for adjusting the screen brightness**

 : Up() / Down() :
Adjusts the brightness of the TFT-LCD display.

- **Status indicator lights**

 POWER : Indicates power status.

Power status	Working (G0/S0)	Sleeping (S1~S4)	Soft Off (G2/S5)	Mechanical Off (G3)
LED Color	Green	Red	Red	Red

 HDD : Indicates the hard disc is working,
LED Color : Green.

4

- **Webcam**

: 130M Pixels built-in, USB port connected.
Instant message software can detect webcam.

Right Sides :

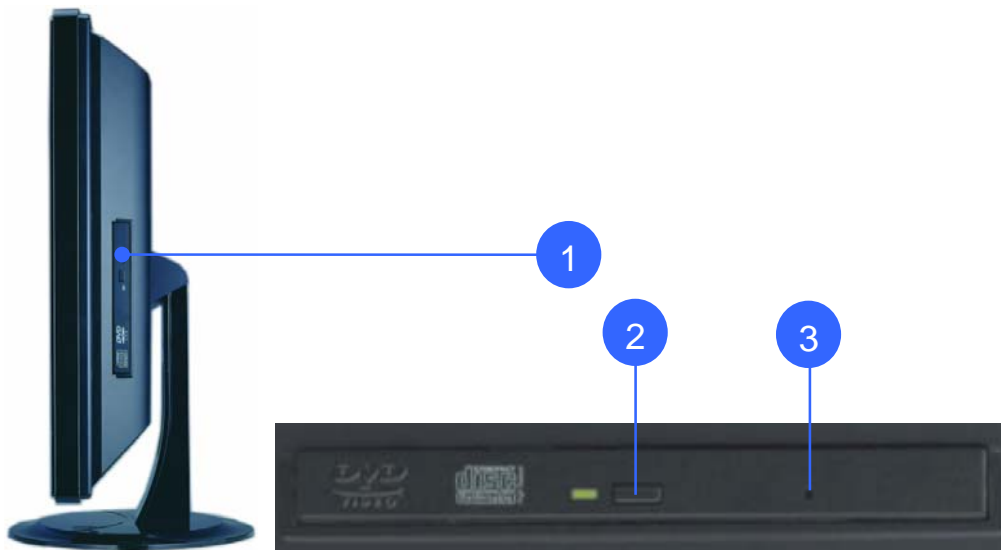

1

Optical Drive

The LCD PC comes in various models with different optical drives. The LCD PC optical drive may support compact discs (CD) and/ or digital video discs (DVD) and may have recordable (R) or re-writable (RW) capabilities. See the marketing specifications for details on each model.

2

Optical Drive Electronic Eject

The optical drive eject has an electronic eject button for opening the tray. You can also eject the optical drive tray through any software player or by right clicking the optical drive in Windows™ "My Computer"

3

Optical Drive Emergency Eject (location varies by model)

The emergency eject is used to eject the optical drive tray in case the electronic eject does not work. Do not use the emergency eject in place of the electronic eject.

Left Sides :

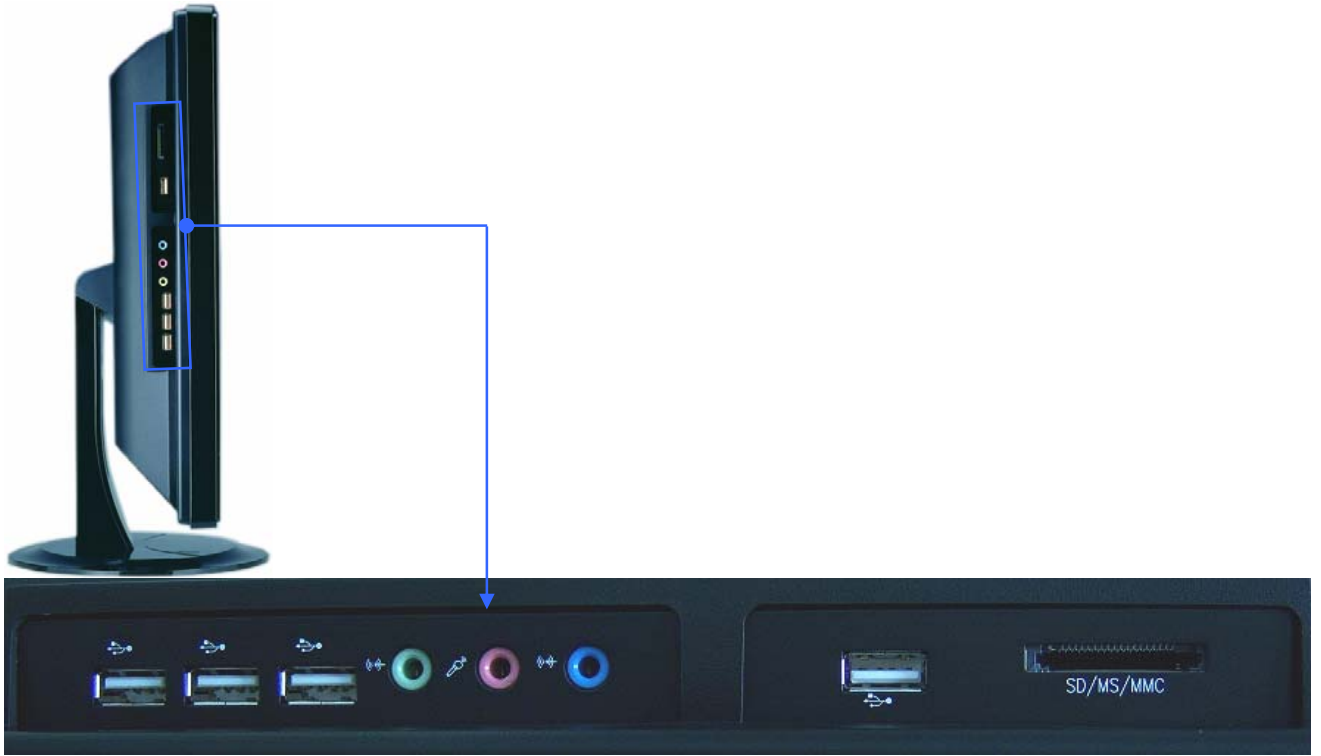

Side I/O Panel

Side I/O Panel	
Icon	Connections
	USB (2.0/1.1) device connection
	External speaker or headphone connection
	External microphone device connection
	Audio input connections for external audio device connection
SD/MS/MMC	Card reader support : SD/MS/MMC.

Rear Sides :

The following picture shows connectors that are for input/output connections located at the rear/side of the main body. Here we provide a brief explanation about the name and function of each connection port.

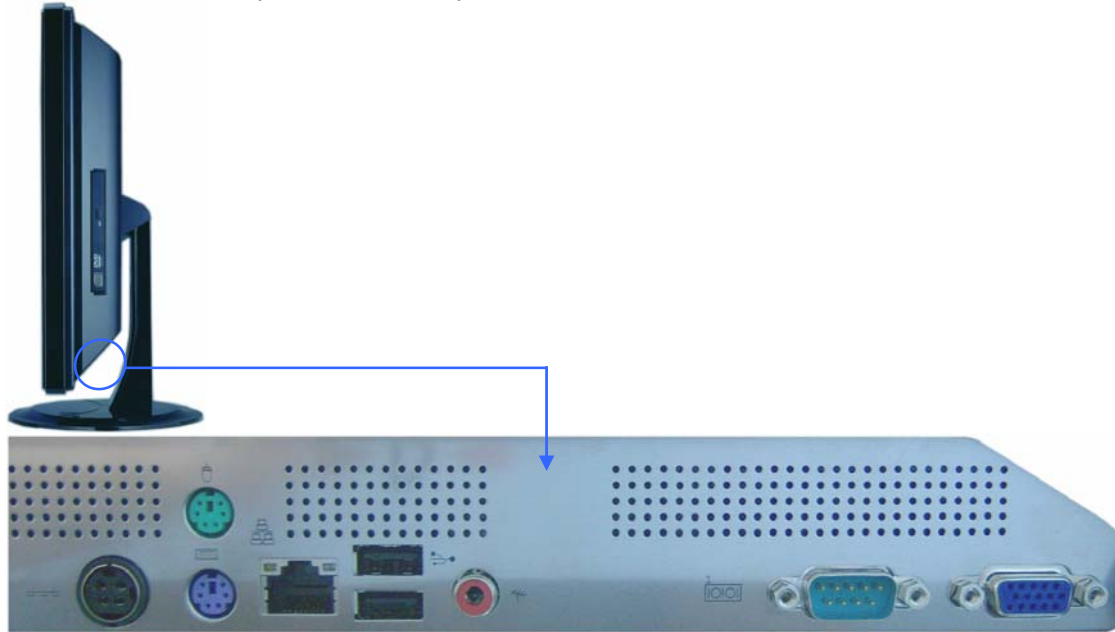

Rear I/O Panel

Rear I/O Panel	
Icon	Connections
	Power Adapter (DC) Input
	PS/2 mouse connection
	PS/2 keyboard connection
	USB (Universal Serial Bus) Port. USB (2.0/1.1) device connection.
	LAN (RJ-45) Port. 10/100 /1000 Mbps network (LAN) cable connection
	Serial communication device connection
	Display (Monitor) Output. The 15pin D-sub monitor port support a standard VGA-compatible device such as a monitor or projector to allow viewing on a larger external display.
	TV Cable Input (If system installed mini-pci tv tuner card, you can insert TV cable into this connector, else this connector is disable).

Install TV cable step :

1. Install TV connector on TV cable

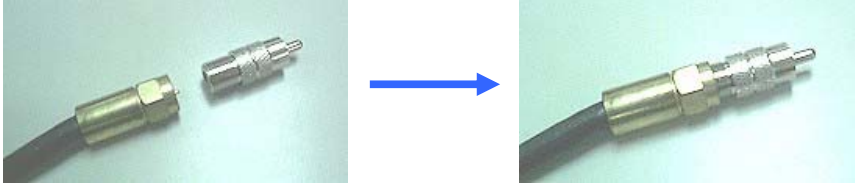

2. Insert TV cable into “TV Cable Input” of rear I/O panel



Chapter 3. Starting the computer for the first time

This chapter will show you how to register a user ID for Windows and for this computer, and how to set up additional drivers and applications step by step.

For Windows Vista Home Edition

Step 0: Windows Vista and basic driver pre-setup

This product is pre-setup with the latest driver file for Windows Vista Home Edition, basic specifications and other optional specifications chosen by the user before shipping.

The following is a list of operating systems and basic driver files that are pre-setup.

- Microsoft Windows Vista Home Edition
- Intel Chipset driver
- Intel Q35 (GMA3100) Video driver
- Realtek ALC888 Audio driver
- Marvell 88E8053 PCI-E Fast Ethernet NIC driver
- Microsoft DirectX

Option :

- TV tuner driver
- Touch screen driver
- Wireless Lan driver
- Bluetooth driver

[For reference]

The touch screen, wireless LAN, TV tuner, Bluetooth (option) must be ordered before the product is packaged and shipped. We regret to inform you that we cannot separately supply a touch screen for products sold without this feature.

Step 1: To set up the computer

To set up the computer that is pre-setup with Microsoft Windows Vista Home Edition in step 0:

1. Connect the mouse and keyboard that come with the main body and turn on the power of the main body. The following “Microsoft Windows Start” dialog box will be displayed. To continue the setup, click <Next> at the bottom of the screen.
2. When the “User’s Time Zone” dialog box is displayed, select the proper time zone for your location and select <Next>.
3. When the “ End Users’ License Agreement” menu is displayed, select “I accept this agreement” and then click <Next>.
4. When you see the “Your Product Key” page on the screen, enter the product key specified in Windows Vista Home Edition user’s guide that comes with the purchase of this PC and select <Next>.
5. A dialog box will appear asking you to designate a computer name. Enter a computer name and computer description in the blanks and click <Next>.
6. A dialog box will appear asking you how you want to connect to the Internet. Select the one that best suits your connection and press <Next>. If your computer is not connected to a network or failed to establish a network connection, a dialog box with “failed to establish an Internet connection” will pop up. If you wish to set up the Internet connection later, click <Skip>. In that case, you can set up or change the network configuration at [Start]-[Control panel]-[Network and Internet connection] after you are finished installing Windows.

7. If you chose a LAN connection for accessing the Internet, a dialog box reading “High speed connection setup” will be displayed. Fill in the fields and press <Next>.

If you chose DSL or cable modem connections, the below dialog box will pop up. Follow the instructions to continue the network connection setup.

8. When you are finished with the Internet connection setup, a dialog box reading, “Are you going to receive verification service?” will be displayed. Even though you can have the verification right away to know whether your copy of Windows is licensed or not, you are recommended to select “No, not at this time.” This is because it is better to activate Windows when you test the computer for a while and you are sure that there are no problems with your new PC. However, you must activate Windows within 30 days.
9. Lastly, you will see a dialog box asking who will use this computer. Enter names of users who will share the computer and press <Next>. To proceed to the next step you have to enter at least one name.
10. When a dialog box that reads “Thank you!” pops up, this means the basic setup is complete. Press <Finish> to reboot your computer and to run Windows Vista.

Step 2: The installation of drivers for other peripherals

Skip this step if you do not use other peripherals.

To use other peripherals this PC supports such as printers, serial communication devices, USB devices, and game consoles/ MIDI devices, connect the device to the main body, press the power button and boot the PC. When booting is complete, install the pertinent driver in the system. Because the system automatically senses and installs plug-and-play peripherals, follow the instructions displayed on the setup menu and refer to the device's user's guide. For peripherals that are not plug-and-play, users have to install the device and reboot the system for normal operation.

Refer to the user's guide of each device for detailed instructions.

Step 3: The installation of software for other peripherals

Skip this step if you do not use other peripherals and go to step 4.

For efficient use of other peripherals (printers, serial communication devices, USB devices, and game consoles/ MIDI devices), install the appropriate software (e.g. utilities or other applications provided by the manufacturer of the device) following the instructions displayed on the setup menu and referring to the user's guide.

Step 4: Completion of setup

When you are finished with step 3, basic installation is complete and the computer is ready to use once it is rebooted.

Chapter 4. Using the computer

In this chapter, we will give a brief explanation about the use of the computer

To Use Windows Vista Home Edition

To use basic Microsoft Windows Vista Home Edition programs and applications that are available with this OS, refer to the user's guide (booklet), or the 'Help and Support Center'.

To refer to the 'Help and Support Center', click [Start]-[Help and Support] on the desktop and click on topics you need to refer to.

Microsoft Windows Vista Home Edition's 'Help and Support Center' provides the following information on a variety of features and other basic operations of Windows Vista Home Edition.

- What's new in Windows Vista
 - Confirmation of license and registration
 - Windows components
- Music, video, games and photos
- Windows Basics
- Networking and the Web
 - Electronic mail and the Web
 - Home network or small scale network
 - The sharing of files, printers, and other resources
 - Cipher and security
 - Networking (including Internet connection)
- Working remotely
- Designation of computer users
- Customizing your computer
- Printing and faxing
- Performance and maintenance
- Fixing a problem
- Send your feedback to Microsoft

Using other applications

To use other applications obtained or purchased separately, refer to the user's guide of each application provided by the software manufacturer.

Partitioning the hard disk

For user's convenience, the hard disk built into this product is divided into two partitions (drive C and drive D). Drive C, a system drive, is installed with a Windows operating system, a variety of drivers, and other applications when you receive the computer. In contrast, drive D, a usual data drive, is empty.

This is to let users store data in drive D to be protected in the event of a system failure. When the hard disk must be reformatted and the system must be reinstalled due to serious damage to the system, only drive C needs to be reformatted while data stored in drive D is kept intact without any intervention.

Chapter 5. System Upgrades

System upgrades

Hardware upgrades

In order to maintain this product's normal operation and the user's safety, we do not provide warranty services when users upgrade the system on their own. If you disassemble the computer, it may cause system damage or electrical shock.

Please contact one of our sales agencies or customer support centers to upgrade the CPU, hard disk, or memory.

Software upgrades

This product is installed with the latest version of Windows Vista and basic driver files before it is shipped. However, manufacturers release new improved versions all the time to meet the user's growing needs, so please upgrade to the latest version for major software that is already installed on this PC on a regular basis at the following sites.

- Windows Vista Home Edition
<http://update.microsoft.com/>
- Basic driver files (Intel video driver, Realtek audio driver.....)
<http://www.rise.com.tw/> (our company web site)

Chapter 6. Reinstalling the OS

Should serious irreparable problems occur, users must reinstall a Windows operating system. This chapter will explain how to do that.

To reinstall the OS, you will need the Microsoft Windows installation CD and the Master CD that comes with this product. Please have these at hand before attempting to reinstall the OS.

It is important to note that users need to back up important data stored in the hard disk prior to formatting the hard disc drive and reinstalling the operating system.

How to reinstalling Windows Vista

1. Insert the Windows Vista Home Edition installation CD into the CD-ROM drive and start up the computer. The “Windows Setup” screen will appear, automatically starting the installation.
2. Continue installing the Windows Vista Home Edition following the instructions displayed on the screen.
3. When installation is complete, the computer will restart running Windows Vista and the desktop will appear. Insert the Master CD and wait for the automatic execution screen to appear.

Choose each driver and application from the automatic execution screen’s selection menu and install them in the following order.

- Install Intel Chipset driver (required)
- Install Realtek ALC888 audio driver (required)
- Install Intel Q35 (GMA3100) driver (required)
- Install Marvell 88E8053 PCI-E Fast Ethernet NIC driver (required)
- Install Microsoft DirectX (optional)
- Install Bluetooth driver (optional)
- Install Wireless LAN driver (optional)
- Install TV Tuner driver (optional)
- Install touch screen driver (essential when installing touch screen)

[Caution]

In most cases, it is necessary to restart the computer after installing drivers or utilities using the Master CD.

[For reference]

When the video driver is installed, click [Start]-[Control panel]-[Appearance and themes]-[Display] to bring up the “Display Registration Information” screen and choose the desired color quality or screen resolution from the [setting] tab. We suggest that users choose high color (16 bit) or true color (24 bit) for color quality, and 1680 X 1050 pixels for screen resolution.

Click on the [Advance] button at the lower part of the [Setup] tab to bring up the ‘basic monitor and Intel Q35 registration information’ page. On this page users can choose from among single mode, mirror mode, and multi mode under “Utility Administrator” in the [Driver Mode Setup] menu. Here, it is possible to set up an output to an external monitor or TV.

The Marvell 88E8053 LAN driver does not need to be installed since Windows Vista provides the same basic functions. However, if users want to use a variety of functions Marvell offers with the driver, it is recommended that they install it.

4. To check the status of each system device after users are finished installing the above mentioned drivers and programs, click [Start]-[Control panel]-[Performance and maintenance]-[System] to bring up the [Hardware] screen in ‘System registration information’. Here click ‘Device administrator’ to check whether each device is working properly. If the yellow exclamation mark is in front of the device’s name or if the name of the device is not displayed, this means the pertinent device is not functioning normally or it is not properly installed. In this case, users have to update or reinstall the driver for that device.

Appendix 1. Troubleshooting

The table below is an outline of general problems that may occur during the use of the PC along with suggested solutions. If any of these problems should occur, proceed with the instructions in the table below or refer to the 'Troubleshooting' topic in Windows' online 'Help'. If the problem persists or if problem descriptions do not describe your problem, contact one of our sales agency or the Customer Support Center.

Table. Trouble shooting

Problem	Countermeasure
Error message reading 'Operating system not found' appears when booting.	Check if the BIOS setup utility properly reads the hard disk. If it turns out that the hard disk is not being read properly, contact the Customer Support Center.
Error message 'CMOS checksum error' appears when booting.	This can occur when the motherboard's CMOS backup batteries have run out. Contact the Customer Support Center to replace the batteries.
Booting to safety mode.	<ol style="list-style-type: none"> 1. This can be caused when the computer was not properly shut down. Click [Start]-[End] to shut off the computer and reboot. 2. This may stem from the failure to read the system environment. Click and execute [Start]-[Program]-[Sub program]-[System tool]-[Disk inspection] and reboot the computer. 3. This may occur when there is a problem with a system device. Click [Start]-[Control panel]-[Performance and maintenance]-[System] and select 'device administrator' under the hardware tab. If you find a problem with a certain device, reinstall the device.

The monitor appears blank or the screen is too dark.	Adjust the screen brightness using the buttons on the front panel of the computer monitor. Should problems persist, contact the Customer Support Center.
Mouse is not working.	<ol style="list-style-type: none"> 1. Check if the mouse is properly connected to the PS/2 port located at the rear of the monitor. The USB cable must be connected to the USB port. 2. This can occur when there is a problem with the mouse device administrator. Click [Start]-[Control panel]-[Performance and maintenance]-[System] and then click on [Device administrator]-[Mouse and other pointing devices] in 'hardware' tab. Remove the mouse item and restart the computer.
Keyboard is not working.	<ol style="list-style-type: none"> 1. Check if the keyboard is properly connected to the PS/2 port located at the rear of the monitor. The USB type must be connected to the USB port. 2. When the system is down, this may occur. Restart the computer and check whether the keyboard is working.
USB device is not working.	<ol style="list-style-type: none"> 1. If the USB device manufacturer provides the driver, install the driver first and restart the computer. 2. Disconnect the USB device and then reconnect it and check if it works properly. (Re-execute the plug-and-play functionality) 3. This may be caused if the system fails to read the USB device or USB device administrator, restart the computer and check if it works properly. 4. To check if there is the problem with the USB device, try connecting it to another computer. If it works fine with the other computer, contact the Customer Support Center.

Unable to shut off the computer.	This could stem from a number of reasons. First, turn off the computer by pressing the power button for more than four seconds. If this does not work, unplug the power cord. If you turn on the computer this time, 'scan disc' will automatically be carried out. If this symptom should repeat, contact the Customer Support Center.
The computer suddenly freezes while in use.	<ol style="list-style-type: none">1. This may be caused by an error in a program. Press <Ctrl>+<Alt>+ and click on 'End now' on the [Windows Task Manager] dialog box.2. This can be caused by an error in Windows. Restart the computer by pressing the power button for more than four seconds.

Appendix 2. Product specifications and system diagram

HARDWARE

CPU

- Intel Core 2 Quad / Core 2 Duo / Dual Core processor
- Socket LGA775 type
- System Bus(FSB) : 1333/1066/800MHz
- L2 Cache : 2MB/4MB (Core 2 Quad / Core 2 Duo / Dual Core)

Chipset

- Intel Q35(North bridge) + Intel ICH9(South bridge)

System Memory

- DIMM x 2 (up to 4GB)
- DDRII 800/667 MHz

System BIOS

- Award BIOS : ACPI 1.0b & USB-FDD Booting Support

Display

- Built-in 22" TFT-LCD Display Monitor (1680x1050, LVDS Interface)
- Integrated Intel Q35 graphic core
- VGA Out : UXGA(2048x1536) Support
- Shared VGA Memory(128/256/384MB) with System Memory
- 2D & 3D Graphics Support

Audio

- AC'97 v2.2 compliant (RealTek ALC888)
- 16bit Stereo Sound
- Built-in 2 Speakers (3W/3W, total 6W)

Storage

- HDD : 3.5" size, SATA II (up to 500GB or above)
- Optional : Slim CD-ROM drive: DVD-ROM & Combo(DVD & CD-RW) drive, DVD Dual.

Input / Output / Peripherals

- PS/2 Keyboard and Mouse port
- Two Serial RS-232C port (1 Internal port for Touch screen support)
- Microphone in / Speaker out / Line in
- One RJ-45 Ethernet connector
- Six USB ports (USB v2.0 compliant)
- Card reader ports for SD/MS/MMC
- One VGA Out
- Webcam 1.3M pixels 1/5 inch CMOS sensor. USB connected.
Effective pixels : 1280 x 1024 SXGA.
Frame Rate : VGA 15fps, SXGA 7.5fps
- TV Cable In (optional)
- Touch screen (optional)
- Bluetooth (optional)

NETWORKING & COMMUNICATION

Networking

- RJ-45, TCP/IP, 10/100/1000 Base-T Fast Ethernet
- Built-in Ethernet Controller: Marvell® 88E8053

SOFTWARE

Operating System

- Microsoft Windows Vista Home / Professional Edition

BIOS Utility Program

- Hardware monitoring utility (CPU Temperature & Voltage, Fan Speed, System voltage)

ENVIRONMENTAL

Environmental Specifications

- Operating temperature 5° to 40°C
- Storage temperature 0° to 60°C
- Humidity 30% to 80% non-condensing

Power Specifications

- DC Input : 20V / 9A

TV Cable Shield :

- When assembly this lcd panel pc in build, the shield of tv cable must connect to ground of build.

REGULATORY COMPLIANCE**EMC / Safety**

- CE
- FCC

PHYSICAL CHARACTERISTICS

- Weight: 10.5 kg (Main Body only)
- Height: 452 mm
- Width: 538 mm
- Depth : 84 mm

WARRANTY

- 1 year warranty standard

MODEL CONFIGURATION

Model	CPU	DDR SDRAM / HDD	ODD / OS

System Block Diagram :

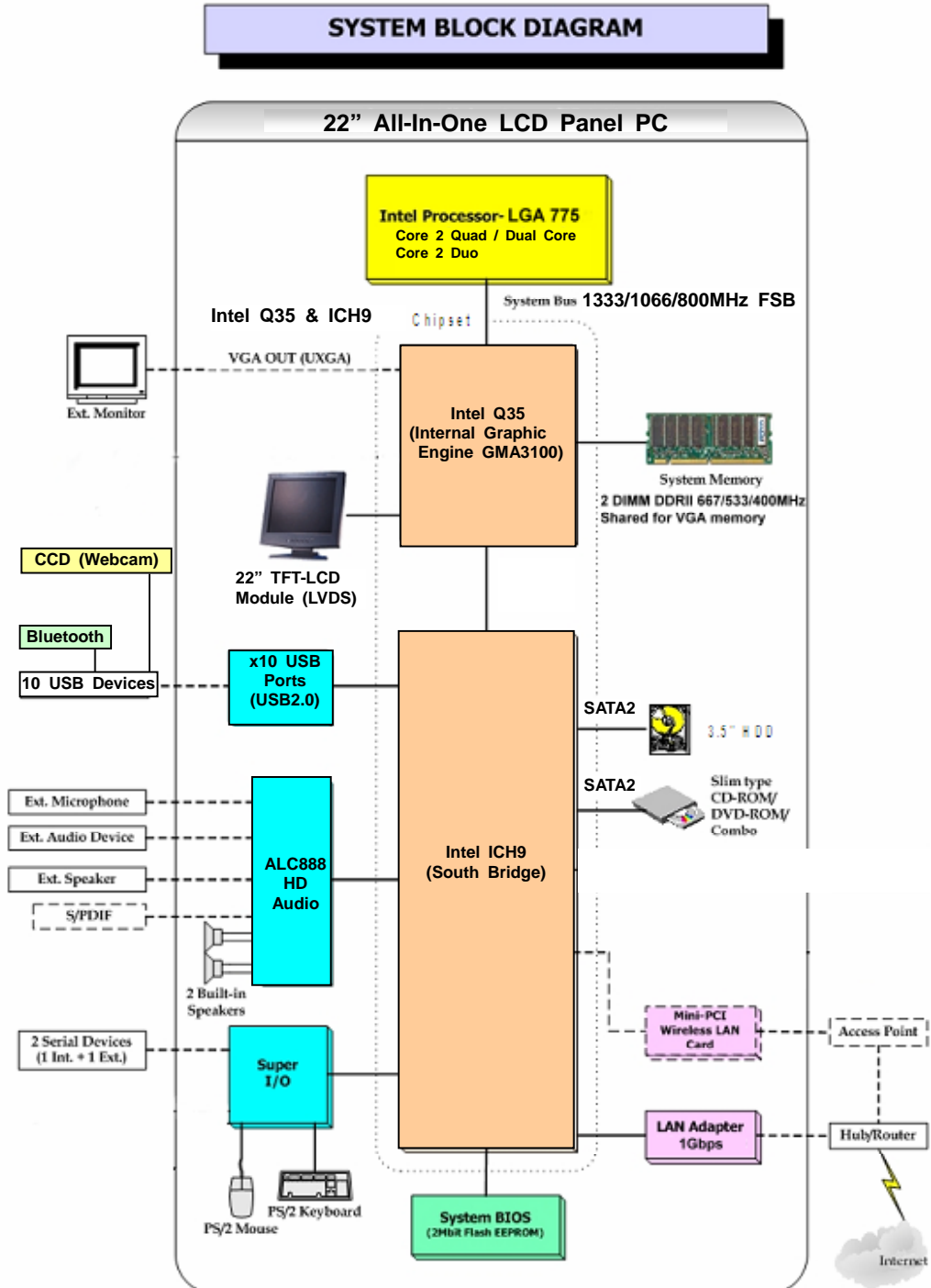

Appendix 3. Product warranty

About the product warranty

1. Keep the product warranty document and complete it with the necessary information when you make the purchase.
2. We do our best to provide the best quality assurance.
3. Even within the warranty period, charges can be applied for those services, which are charge-based.
4. We do not make compensation for all the dependent losses due to trouble of the product.
5. In order to kept safety and stability of equipment do not adjust stand fixed.
6. If our label removed the warranty is void.

Product warranty

We guarantee as follows.

- 1) This product is manufactured with strict quality assurance and inspections
- 2) The free warranty service period is one year from the date of purchase.
- 3) When requesting repair, please show the warranty document to the service representative.
- 4) We do not reissue warranty documents, so keep them with care.
- 5) Contact the agency from which you made the purchase if there is problem with this PC. If it is something that cannot be handled by the agency, contact our Customer Support Center to ask for technical support. This way, your needs will be looked after appropriately.

Charge-based service

The following services are charge-based.

- Malfunction or damage to the product due to careless handling by the user.
- Problems caused by software
- Damage caused by natural disaster
- Damage or changes to the product that is done by people other than our service representative.
- Problems resulting from trouble with the power source

Recommendations and caution

- 1) Position this product away from direct sunlight or magnetic waves. If those factors are unavoidable, find ways to protect the product.
- 2) Please equip with (A.V.R) or (Power Conditioner) with enough capacity for a stable operation.
- 3) If users do not have the warranty document or have not completed the warranty document, they can receive free or charge-based warranty services according to the guidelines specified in the Consumer Protection Law.

Model Name
(RS-5622-XXXXXXXX)